

# ARMOR™

The only fifth wheel designed specifically for yard trucks

## Fontaine® Armor™ Yard Truck Fifth Wheel

### Instructions



- Pre-service and operation
- Coupling instructions
- Inspection & maintenance

**FOR YOUR SAFETY USE ONLY GENUINE FONTAINE  
FIFTH WHEEL SERVICE PARTS. USING PARTS  
THAT DO NOT MEET FONTAINE SPECIFICATIONS  
WILL VOID WARRANTY.**



*Scan to view operation video or go to:  
[fifthwheel.com/armor](http://fifthwheel.com/armor) ... then choose "Training"  
in menu then choose "Operating Instructions".*

  
**FONTAINE**  
FIFTH WHEEL®

# Introduction

---



## Warning!

**WARNING!** The visual inspection is required by law. Some improper couplings can pass a “tug test” and sound is not reliable to verify proper coupling. The coupling procedure is not complete without a visual inspection. It is necessary to get out of the yard truck and look. Incorrect coupling could cause the trailer to disconnect, possibly resulting in serious personal injury or death.

**WARNING!** When coupling, the fifth wheel must lift the trailer. Lifting the boom while the fifth wheel is underneath the trailer may result in damage to and incorrect coupling of the fifth wheel, possibly resulting in serious personal injury or death.

**WARNING!** Do not use any fifth wheel that has damaged components or fails to operate properly.

**WARNING!** Failure to follow these specifications will void the warranty and could affect product performance.

**WARNING!** Air cylinder(s) should not be disassembled as contents are under pressure.

**WARNING!** The Fontaine Armor air cylinder has a factory installed 3-way air valve. The 3-way valve is a bronze colored piece that is attached to the input of the air cylinder. The air line should be plumbed directly to the input of the 3 way air valve. The valve allows the cylinder to freely exhaust when the fifth wheel closes, and is necessary to ensure that the fifth wheel functions properly.

**DO NOT REMOVE THE 3-WAY VALVE. Removing the 3-way air valve voids the warranty.**



## Introduction

### HOW TO TELL IF THE FIFTH WHEEL IS PROPERLY LOCKED

Verify secure coupling with a “tug test” by easing the yard truck forward (with the trailer brakes on) to feel resistance of the load. Set parking brakes on the yard truck and trailer and get out of the yard truck and visually inspect (using a flashlight if necessary) that the fifth wheel is properly closed.

**The locking jaw must be fully across the throat of the fifth wheel. There must be no gap between the fifth wheel and the trailer plate. There must be no gap between the secondary lock and the air cylinder tube when locked (the air cylinder rod should not be visible).** All three areas of the fifth wheel must be inspected to ensure that the fifth wheel is properly coupled.

**Below are three critical areas of visual inspection that drivers must perform after every couple.**

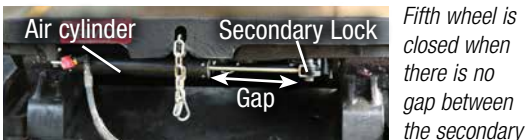
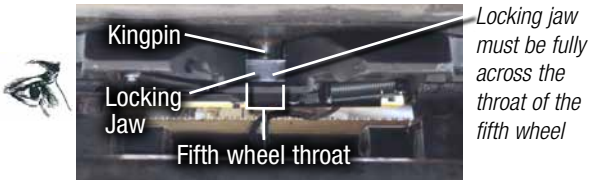

Open position. Yard truck not attached to trailer!



Closed position. No Gap; air cylinder rod is not visible.

**If the visual inspection indicates that you failed to obtain a proper couple, open the fifth wheel, inspect for damaged components, and repeat the coupling sequence.**

# Introduction

---

For over 70 years, Fontaine has been exceeding customer expectations by building fifth wheels with innovative technology, uncompromising quality, and features designed to ensure cost-efficient performance.

This handbook provides instructions and recommended procedures to ensure optimum performance from your new Fontaine® Armor™ fifth wheel.

**Keep this handbook in the yard truck after your fifth wheel has been installed.**

For convenience, record fifth wheel information below:

Model: \_\_\_\_\_

Serial number: \_\_\_\_\_

In service date: \_\_\_\_\_

**Serial number.** The serial number is located underneath the top plate on the top left side of the casting, under the air cylinder (see yellow arrow).



If you have any questions concerning your new fifth wheel, our Customer Service Department is available to help you at 800-355-6377 (toll free).

**Note:** For warranty information:  
email: [info@fifthwheel.com](mailto:info@fifthwheel.com)

For installation information go to:  
<http://www.fifthwheel.com/armor/>

Contents	Pages
Section I – Pre-service and operation . . . . .	5-8
Section II – Coupling instructions . . . . .	9-14
Section III – Inspection and maintenance .	15-18

## Section I – Pre-service and operation

Always check for damage due to improper handling or delivery practices prior to starting recommended pre-service procedure.

### A. Fasteners

Make sure all nuts and bolts are in place and properly tightened.

Check to see if both bracket pins are secured by a cotter pin or roll pin (pictured with cotter pin). (see FIGURE 1).

**FIGURE 1: Bracket pin**



# Pre-service and operation

## B. Lubrication

1. Tilt the top plate forward (front of the fifth wheel down) and apply grease to each bearing area through the zerk fitting. Armor™ has two fittings located on each side of the top plate. Continue to apply grease until it is coming out of the back of the bearing. A substantial amount of grease may be required initially to fill the reservoir. Tilt the wheel to the rear (rear of the wheel down) and repeat the procedure. Rock the top plate back and forth several times to spread the grease over the bearing surface.

Inspect the trailer kingpin plate and top surface of the fifth wheel to make sure each is properly greased. A liberal coating of grease should be applied to the complete surfaces of both the trailer kingpin plate and the top surface of the fifth wheel. A paddle or brush will make this job easier.

The additional thickness of this material can prevent the proper operation of the fifth wheel and can cause a dangerous condition.

2. Lubricate the fifth wheel prior to opening and closing (see FIGURE 2). Grease the jaw on top and bottom. Open and close the fifth wheel several times to further distribute the grease.

**FIGURE 2: Jaw location**

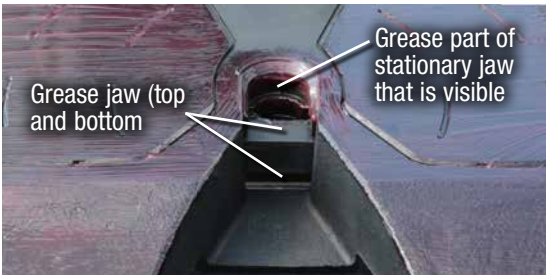

Fontaine suggests the use of a Moly based lubricant such as Mobilgrease XHP320 or equivalent when applying lubricant to the locking jaw.

Lightly oil other moving parts in the fifth wheel. (Areas or regions that experience extreme and/or prolonged freezing temperatures should consider using a less viscous substance. Fontaine suggests contacting your specific lubricant manufacturer for guidelines on mixing compatibility of any lubricant). In cold weather

## Pre-service and operation

applications please refer to technical bulletin TECH-001. Technical bulletins are available at [www.fifthwheel.com/armor](http://www.fifthwheel.com/armor) -- Choose "Literature" tab.

3. Grease the top plate (see FIGURE 3). Spread grease all over the mating surface of the top plate. Be sure the grease pockets built into the top plates are full of grease.

**FIGURE 3: Top Plate**



### C. Operation

1. Operate the Fontaine Armor™ yard truck fifth wheel by cycling the air cylinder with the fifth wheel switch located in the cab of the yard truck.
2. To open, hold the valve open until the locking mechanism is locked in the open position. If your truck is equipped with the optional fifth wheel interlock, set the trailer brakes before cycling the fifth wheel.
3. Close the Fontaine Armor™ using a using a test kingpin (Fontaine Parts Connection part number ARMORKPK). Repeat several times making sure that all moving parts have adequate lubrication.

# Pre-service and operation

## D. Knock-out rod

The knock-out rod requires no adjustment (see Figure 4) and is used to release a tight jaw (hard to open) by tapping the rod with a hammer. The knockout rod can be screwed in and out for better leverage.

**FIGURE 4: Knock-out rod**

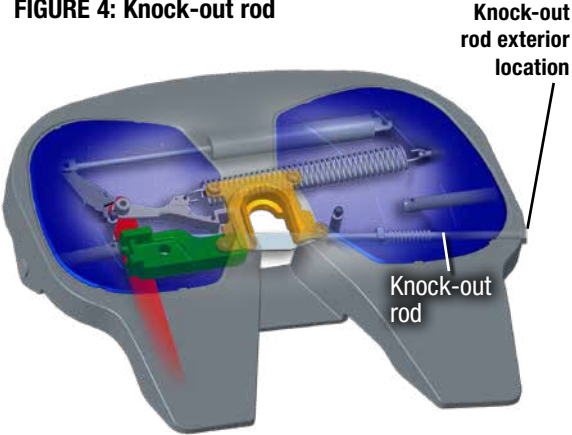



# Section II – Coupling instructions

### COUPLING PROCEDURE:

1. Prior to coupling, inspect the fifth wheel to ensure a proper operation.
  - Examine the mounting assembly for securely fastened bolts.
  - Tilt the fifth wheel up and down to make sure that it moves freely. Rest the fifth wheel in the proper position by tilting it to the rear of the yard truck and resting it on the stops.
  - Check the surface for a liberal coating of grease. The indented pockets on top of the fifth wheel act as a grease reservoir for the top surface and should be filled with grease.
  - Actuate the air cylinder and check for air leaks.  
**WARNING: AIR CYLINDER DISASSEMBLY SHOULD NOT BE ATTEMPTED.**
  - The fifth wheel should be in an unlocked (open) position (see FIGURE 1). When unlocked (open), there will be a gap between the air cylinder and the secondary lock and the fifth wheel throat will be unobstructed. **DO NOT TRY TO COUPLE TO A CLOSED FIFTH WHEEL.**

**FIGURE 1 – Open and closed positions**



Open position. Yard truck not attached to trailer!

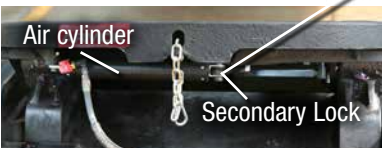

Closed position. No Gap; air cylinder rod is not visible.

*Fifth wheel is closed when there is no gap between the secondary lock and the air cylinder tube when locked.*

## Coupling instructions

- The trailer kingpin should also be inspected prior to coupling. The kingpin plate should be fully reinforced and of sufficient size to completely cover the fifth wheel. If the kingpin plate is too narrow, the uncovered portion of the fifth wheel will collect dirt and foreign matter. This material may work into the fifth wheel locking mechanism, causing wear and occasionally difficult uncoupling. This material can also cause galling of the fifth wheel and/or kingpin plate.

If the trailer kingpin plate is not fully reinforced, distortion can result causing:

- Non-uniform loading
- Variation in kingpin length
- Cutting and galling of the fifth wheel or kingpin plate

If the trailer kingpin plate is distorted enough to cause any of the conditions listed above, we recommend that a new plate be installed.

The trailer kingpin plate must be properly greased.

Fontaine Armor fifth wheels are designed and manufactured for use with all trailer kingpins that conform to SAE specifications, SAE J700, February 1993 and subject to the wear limits of SAE J2228, June 1993. These specifications cover SAE 2" kingpins only.

The SAE standard kingpin can be checked using the dimensions given below (see FIGURE 2).

**FIGURE 2: SAE standard king-pin (SAE J700, FEB 93)**

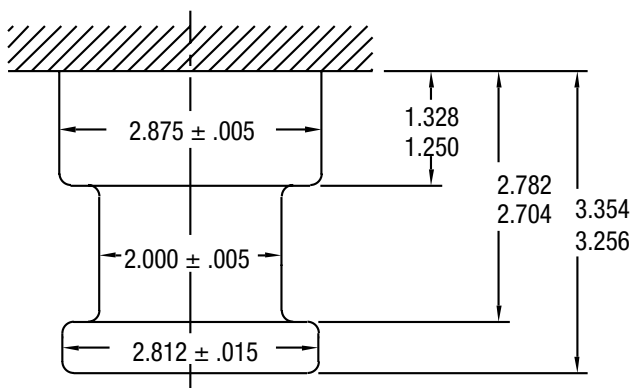

## Coupling instructions

3. Proper yard truck/trailer alignment is critical to obtain a secure coupling and to avoid equipment damage.

Coupling should not be attempted if the trailer is too low. Costly damage may be incurred to the trailer, the kingpin, the kingpin plate, the fifth wheel, and the entire yard truck drivetrain.

4. To couple the fifth wheel to the kingpin, be sure the fifth wheel is positioned so that it tilts down at the rear and is resting on the stops.

Line up straight with the trailer and back up slowly. (see FIGURE 3). Stop just before reaching the trailer to adjust boom. Slowly back up, positioning ARMOR under trailer.

**FIGURE 3**



Raise boom until ARMOR flattens out against trailer plate (see FIGURE 4).

**FIGURE 4**



Back up slowly to engage kingpin (see FIGURE 5)

**FIGURE 5**



## Coupling instructions

---

Coupling is complete when the fifth wheel locking mechanism snaps closed behind the kingpin.

Verify secure coupling with a "tug test," by easing the yard truck forward, with trailer brakes on, to feel resistance of the load. If the coupling feels secure, visually inspect the fifth wheel. The jaw must be locked in place behind the kingpin, completely across the throat of the fifth wheel. Connect a tertiary lock to the secondary lock when using the Fontaine Armor outside the private yard to prevent inadvertently opening the fifth wheel (See FIGURE 6).

**FIGURE 6:** Tertiary lock



**WARNING!** Raising the boom while incorrectly positioned underneath the trailer may result in damage to and incorrect coupling of the fifth wheel, possibly resulting in serious personal injury or death. Do not raise boom directly under kingpin.



The visual inspection is required by law. Some improper couplings can pass a "tug test" and sound is not reliable to verify proper coupling. The coupling procedure is not complete without a visual inspection. It is necessary to get out of the yard truck and look. Incorrect coupling could cause the trailer to disconnect, possibly resulting in serious personal injury or death.

# Coupling instructions

## HOW TO TELL IF THE FIFTH WHEEL IS PROPERLY LOCKED

Verify secure coupling with a “tug test” by easing the yard truck forward (with the trailer brakes on) to feel resistance of the load. Set parking brakes on the yard truck and trailer and get out of the yard truck and visually inspect (using a flashlight if necessary) that the fifth wheel is properly closed.

**The locking jaw must be fully across the throat of the fifth wheel. There must be no gap between the fifth wheel and the trailer plate. There must be no gap between the secondary lock and the air cylinder tube when locked (the air cylinder rod should not be visible).** All three areas of the fifth wheel must be inspected to ensure that the fifth wheel is properly coupled.

**Below are three critical areas of visual inspection that drivers must perform after every couple.**



*Locking jaw must be fully across the throat of the fifth wheel*



*No gap between trailer bottom and fifth wheel*

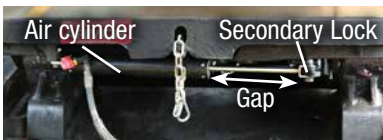

Open position. Yard truck not attached to trailer!

*Fifth wheel is closed when there is no gap between the secondary lock and the air cylinder tube when locked*

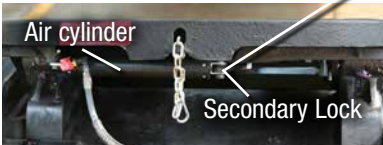

Closed position. No Gap; air cylinder rod is not visible.

**If the visual inspection indicates that you failed to obtain a proper couple, open the fifth wheel, inspect for damaged components, and repeat the coupling sequence.**

## Coupling instructions

---

### UNCOUPLING PROCEDURE:

1. Prior to uncoupling, set the trailer parking brakes. Back the yard truck gently against the trailer. This will release the load on the fifth wheel locking mechanism.
2. Block the trailer wheels. If poor ground conditions exist you may have to provide a base for the trailer landing gear.
3. Lower boom until landing gear is on the ground.

**DO NOT RAISE TRAILER OFF OF THE FIFTH WHEEL.**

4. Open fifth wheel using the in-cab release switch.
5. Slowly drive yard truck from under trailer.

### **Section III – Inspection and maintenance procedures**

**WARNING! Do not use any fifth wheel that has damaged components or fails to operate properly.**

Fontaine recommends that preventative maintenance be performed after 90 days or 750 hours, whichever comes first and every 90 days or 750 hours thereafter.

Note: P.M. intervals are recommended based on standard duty applications. Applications more severe than standard duty may require different P.M. intervals to ensure peak performance.

Using a suitable solvent, degrease the fifth wheel and mounting brackets and inspect for:

1. Cracks in the fifth wheel assembly, mounting brackets, and mounting parts.
2. Wear and/or damage to moving parts.
3. Loose nuts and bolts in the fifth wheel and in the mounting hardware.
4. Securely fastened and properly working springs.
5. Check to see if both bracket pins are in place and secured by cotter pin or roll pin.
6. Rock the fifth wheel front to back on the brackets. If the fifth wheel does not rock freely, remove the top plate and inspect the bracket liners. Replace liners that are broken or have worn excessively.
7. Check for air leaks in the cylinder and supply line.

# **Inspection and maintenance procedures**

---

## **Lubrication**

Follow the instructions provided in the Pre-Service Procedure on pages 5-8.

Periodically remove the fifth wheel to clean old grease from the bracket grease channels to help insure an even grease distribution of fresh grease (see FIGURE 1 on next page).

Special precautions should be taken during cold weather to ensure that the Fontaine Armor locking mechanisms operate freely. Ice and sludge can build up and lubricants will become thick and can bind at low temperatures. In cold weather applications, please refer to technical bulletin TECH-001, available at [fifthwheel.com/armor](http://fifthwheel.com/armor)

Lubricate the fifth wheel prior to opening and closing. Grease the jaw on top and bottom. Distribute the grease along the full length of the jaw mating surfaces. Open and close the fifth wheel several times to further distribute the grease.

**Fontaine suggests the use of a Moly based lubricant such as Mobilgrease XHP320 or equivalent when applying lubricant. Areas or regions that experience extreme and/or prolonged freezing temperatures should consider using a less viscous substance. Doing so will help ensure proper movement/lubrication of the latching mechanism. Fontaine suggests contacting your specific lubricant manufacturer for guidelines on coldmixing compatibility of any lubricant. In cold weather applications please refer to technical bulletin TECH-001 Technical bulletins are available at [fifthwheel.com/armor](http://fifthwheel.com/armor)**

The regular performance of the routine, "90-Day/750 Hour Preventative Maintenance Procedure," is also recommended.



## Inspection and maintenance procedures

**FIGURE 1:** Clean oil/grease all moving parts (arrows)

**Clean oil/grease all moving parts (arrows)**

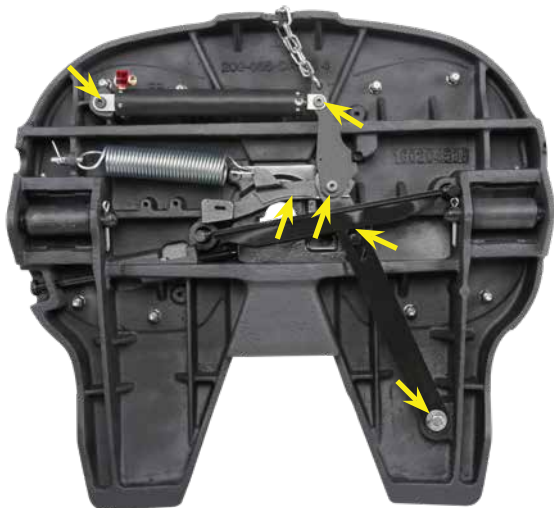





**For sales and service locations or for additional copies of this handbook go to [www.fifthwheel.com/armor](http://www.fifthwheel.com/armor) or contact Fontaine Fifth Wheel Customer Support at 800-355-6377 (toll free).**

**or email:**

**[info@fifthwheel.com](mailto:info@fifthwheel.com)**



*Scan to view operation video or go to: [fifthwheel.com/armor](http://fifthwheel.com/armor) ... then choose "Training" in menu then choose "Operating Instructions".*



Fontaine Fifth Wheel  
3520 Industrial Way • Jasper, AL 35501  
[www.fifthwheel.com/armor](http://www.fifthwheel.com/armor)